



RMLC Visor

Revision 2.7

The Rapid Manufacture Low Cost (RMLC) Visor is designed to fill the immediate need of personal protective equipment in the current Covid-19 crisis. Several features aid its **ease of production and logistics**:

- Just one die cut or laser cut part
- Minimal manual labour is needed
- Flat pack and no use of foam or rigid frame lowers the shipping volume
- A wide range of head band material choices based on availability
- High rigidity allows the use of material saving 0.25 mm (10 Mil) plastic sheets

Several features improve **comfort and usability**:

- Lightweight design at around 40 g (1.4 oz)
- Easy and quick assembly in less than 60 seconds
- Very little plastic comes into contact with the skin
- A large and also high shielded area
- An open airpath at the top helps against fogging
- Easily adjustable distance to the face allows for larger respirators to be used
- Easy to disinfect and reuse



A medical visor/face shield is no replacement for a respirator. It is meant to protect the wearers eyes and skin from droplets. It can't protect the wearer from inhaling aerosols. A respirator still needs to be worn underneath.



Disinfectability and thus reusability of this visor design is entirely dependent on the used materials. Please consult your chosen materials' datasheets whether they can withstand chemical or heat disinfection.

Creative Commons License

This design for a medical visor is created and owned by Henning Marxen and is licensed for non-commercial use under the Creative Commons Attribution-Non Commercial 4.0 International Public License (<https://creativecommons.org/licenses/by-nc/4.0/legalcode#s2b>) ("the CCL Terms"). NonCommercial means not primarily intended for or directed towards commercial advantage or monetary compensation. A distribution compensated at cost of manufacture is permitted!

Terms and Conditions

As set out in Section 5 of the CCL Terms, no representations or warranties of any kind concerning the Design are given. By downloading and or using the Design files, you:

- accept and agree to the CCL Terms.
- acknowledge that:
 - this Design has been created by Henning Marxen in response to the global COVID-19 pandemic;
 - Henning Marxen has no prior expertise in the design and manufacture of Personal Protective Equipment and therefore this Design has neither been made by reference to any specific regulations nor subject to any formal testing regime;
 - that any user of the Design shall assume all responsibility for developing the design in conformity with regulatory and testing requirements of any markets it intends to make the visor available in.

Thanks for either feedback, prototyping, testing or other support go out to:

#EUvsVirus
P&G InQbet
Ford USA
Bleher Folientechnik

Polystanz AG
Nadja Werner
Liam Murphy
Gillian Berry

Henning Marxen 2020
Bremen, Germany
www.rmlc-visor.eu
rmlc@marxen.design

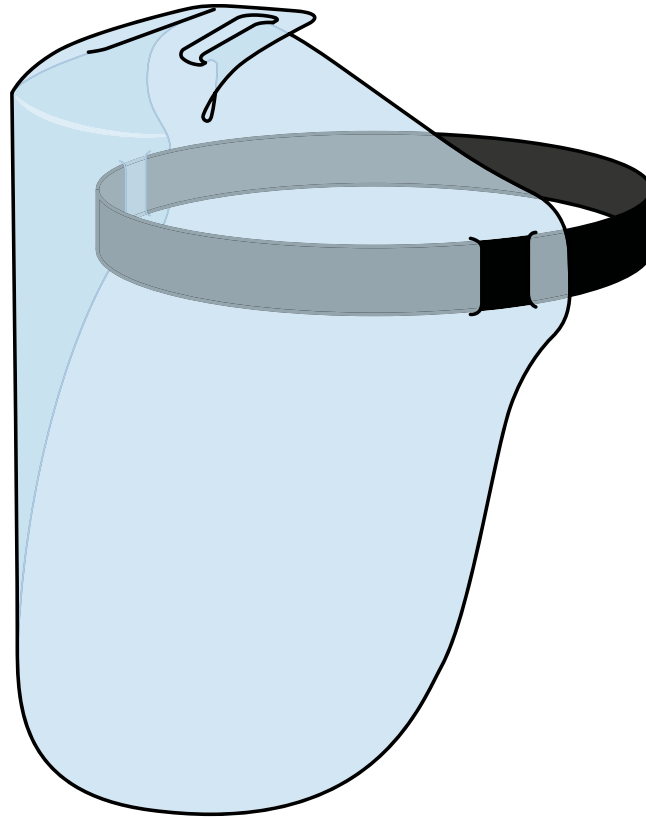

Manufacture and Materials

For this design a 25 mm (1") head band with an opening mechanism is needed. For example, an elastic ribbon with a snap button, an adjustable nylon strap or a length of double-sided Velcro. For Velcro, micro hook Velcro has shown to be the cheapest option which also doesn't tangle with hair or sticks to clothing.

0.25 mm (12 Mil) strong biaxially-oriented polyester (BO-PET) is recommended as the visor material. Regular PET, PETG or polycarbonate are good substitutes. However, different materials may need different thicknesses. Feedback on tested material and thickness combinations is always welcome.

The headband slots are generously sized. The tighter you can size them to your chosen headband material, while keeping it easy to assemble, the more stable the visor will sit.

[Instructions \(Page 5\)](#)

[Vector Stencil Large/Medium \(Page 6\)](#)

[Vector Stencil Small \(Page 7\)](#)

①

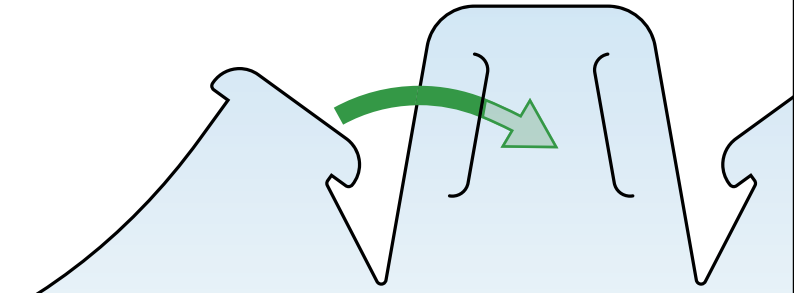

②

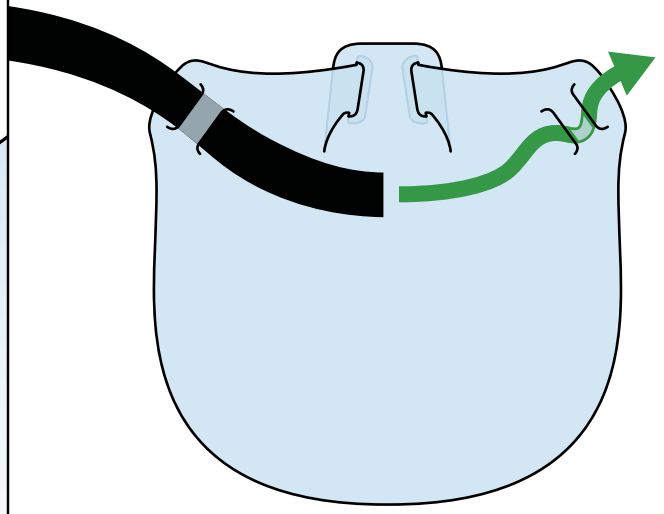

③

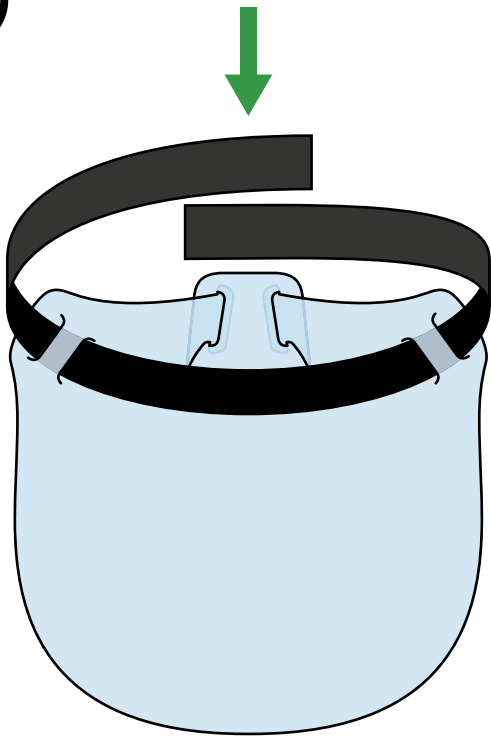

④

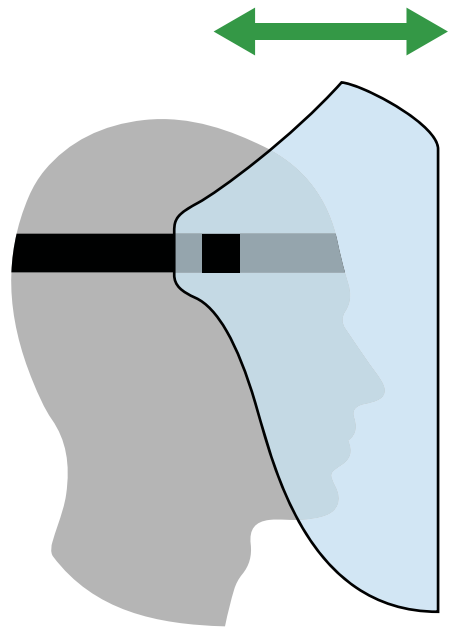

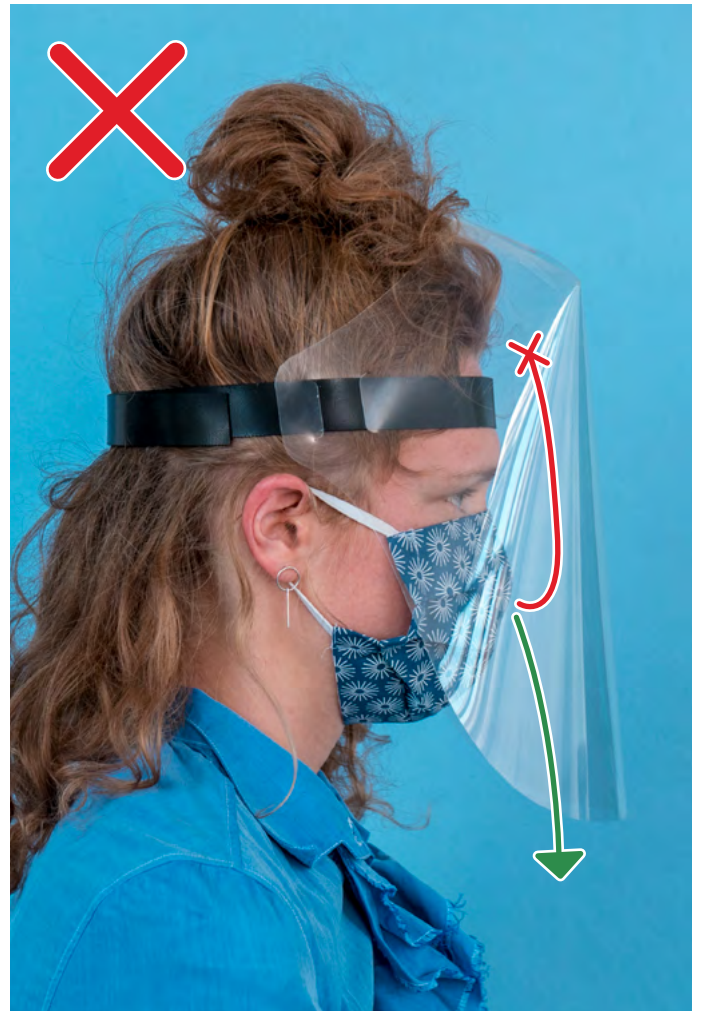

LARGE /
MEDIUM



Stencil Large/Medium

This is a 1 to 1 Vector Stencil.
Give this PDF to your laser cutter
technicians. Ask them to laser
page 6 and to delete the text and
arrows. They will know how to
handle the files.

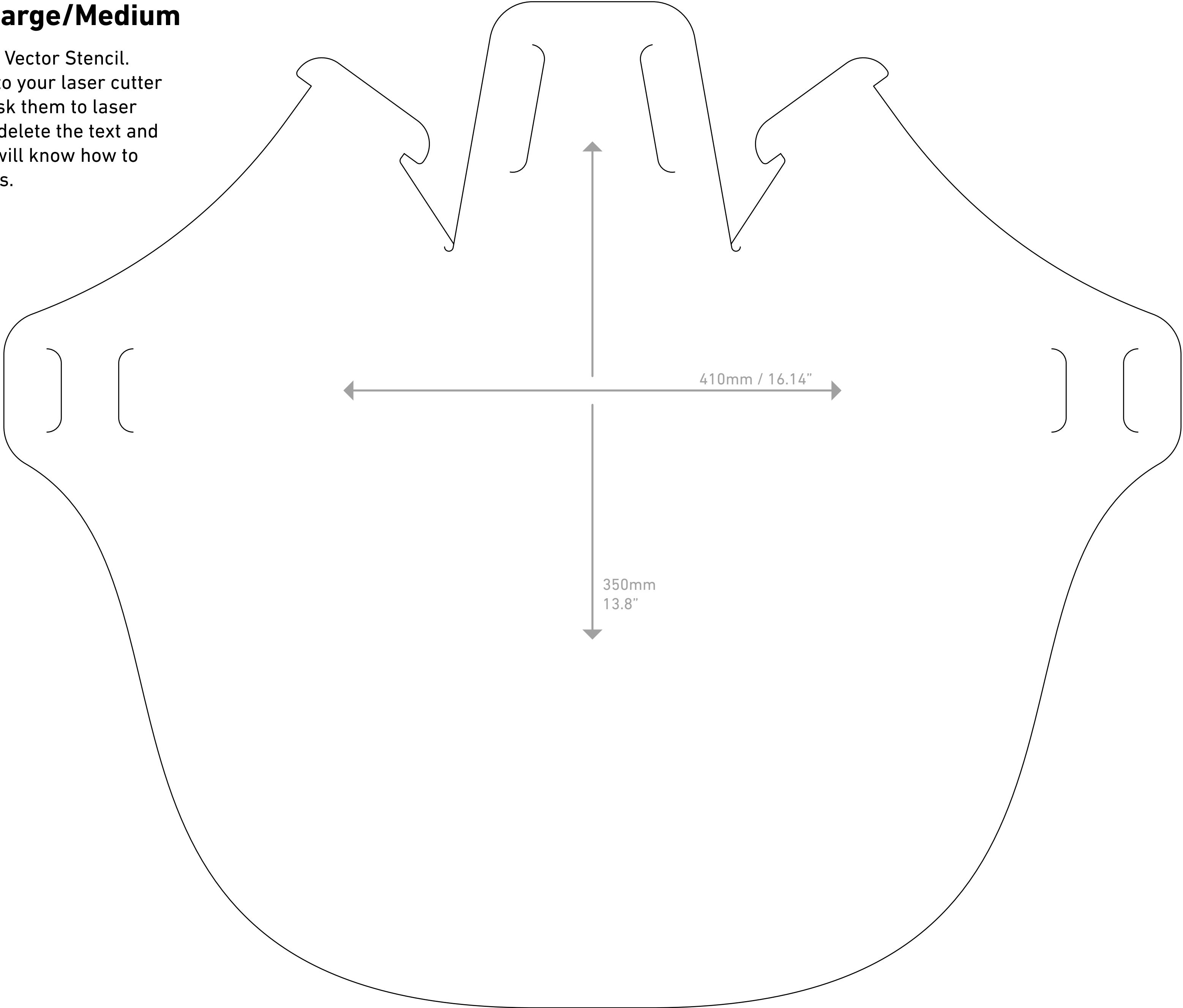

SMALL



Stencil Small

This is a 1 to 1 Vector Stencil.
Give this PDF to your laser cutter
technicians. Ask them to laser
page 7 and to delete the text and
arrows. They will know how to
handle the files.

